







## A Hierarchical Multilevel Modeling Framework for the Creation of High-Quality Solid Models in Parametric Feature-Based CAD Systems

Pedro Company<sup>1</sup>, Manuel Contero<sup>2</sup>, Jorge D. Camba<sup>3</sup>, Aritz Aranburu<sup>4</sup> and Daniel Justel<sup>4</sup>

<sup>1</sup> Universitat Jaume I, [pcompany@uji.es](mailto:pcompany@uji.es)

<sup>2</sup> Universitat Politècnica de València, [mcontero@upv.es](mailto:mcontero@upv.es)

<sup>3</sup>Purdue University, [jdorribo@purdue.edu](mailto:jdorribo@purdue.edu)

<sup>4</sup> Mondragon Unibertsitatea, [aranburug@mondragon.edu](mailto:aranburug@mondragon.edu)

<sup>4</sup> Mondragon Unibertsitatea, [djustel@mondragon.edu](mailto:djustel@mondragon.edu)

Corresponding author: Pedro Company, [pcompany@uji.es](mailto:pcompany@uji.es)

**Abstract.** Building on the premise that quality is a complex and multifaceted concept, we advocate for the structuring of the concept of quality in engineering design parametric CAD modeling by using three hierarchical levels. The goal is to successfully parse whether CAD models are usable, reusable, and semantically rich. Our classification results from emphasizing three sequential objectives that the models must accomplish: (1) being free from geometric and topological errors, (2) being modifiable without causing regeneration errors that may hinder reusability, and (3) being able to properly convey design intent while enabling design exploration and enabling CAD models to become digital twins. In this paper, we elaborate on the proposed framework and discuss its implications. Our grouping facilitates the matching of the six dimensions, which cover all aspects of CAD quality, with the two more commonly considered aspects of usability and reusability. Additionally, it highlights the fact that the third level is generally ignored and that the three aspects must be arranged and considered in a sequential manner. Finally, it opens the door to further advances in the automatic quantification of parametric CAD quality.

**Keywords:** Parametric modeling methodologies, CAD quality, CAD reusability, Design Intent

**DOI:** <https://doi.org/10.14733/cadaps.2025.229-244>

### 1 INTRODUCTION

In the last decade, the leading companies in the manufacturing sector have gradually adopted the use of 3D models as the authoritative source of information for product definition (e.g. [27]). This Model-Based Definition (MBD) strategy represents a shift from 2D drawings to 3D CAD models as carriers of product-related information. A Model-Based Enterprise (MBE) uses MBD to drive all aspects of the product lifecycle. The idea is that data is created once and reused by all downstream activities. In these environments, product data quality has been recognized as of critical importance for both horizontal and vertical data integration (communication and sharing of product data across parallel



and successive product development processes, respectively), and some standardization efforts have been attempted [30]. Nevertheless, the problem is far from solved.

The driving idea in this paper is that both the academic and industrial communities have failed to recognize and solve the problem of low quality in procedural CAD modeling, which prevents the deployment and adoption of MBD to its full potential.

It is often assumed that creating a parametric 3D model ([6,43]) with a modern CAD system automatically ensures that the model can be subsequently modified and reused without any effort. However, nothing could be further from the truth [9,25]. CAD systems have become complex and sophisticated instruments that offer countless alternatives for the construction of a 3D model. Determining how the CAD model must be built is critical to ensure the quality of the outcome. Faced with the impossibility of editing parametric models, some companies leverage workarounds such as the integration of direct editing strategies for local adjustments of the geometry to comply with internal deadlines. These practices negate the intrinsic benefits that parametric geometry can provide for the automatic generation of design alternatives, design optimization, and the application of artificial intelligence techniques in the future [4].

This paper is intended to give visibility to the problem of parametric CAD quality. It has been described elsewhere that "Product data quality will not improve unless product data system users, the engineers they work with, and their managers are rewarded for producing high-quality product data or deterred from producing poor quality product data" [41]. But one needs means, as well as desire. Our goal here is to provide a new framework to quantify all the facets of quality, thus enhancing the technological capabilities of many industrial sectors powered by high-quality CAD models.

The framework is designed to interrelate and enhance the existing quality techniques that have proven useful for validating certain aspects of quality. We also bring to light current gaps where additional techniques remain to be developed in order to achieve a fully comprehensive evaluation of CAD quality. We foresee the proposed framework as a necessary step in the development of a future modeling strategy that can overcome the two limitations of current methodologies: (1) current methodologies seem to be effective because they are not used outside their limited range of application, and (2) our view of quality is that it is neither reasonable nor efficient to completely give up quality, or try to maximize it in cases where it may not be necessary.

The paper is structured as follows. First, we review the state of the art in CAD quality. Then, we explain our vision, which builds on the three-level methodology developed by Contero et al. [12] and the six dimensions of parametric CAD quality proposed by Company et al. [13]. We approach the problem from the following hypotheses:

- H1. Current modeling methodologies are incomplete, as their effectiveness depends on the complexity of the model.
- H2. Current methods ignore the potential of hierarchical evaluation to accommodate quality requirements to the expected life of each model.
- H3. The six dimensions of parametric CAD quality can be clustered into three hierarchical levels of quality aimed at ensuring that CAD models are usable, reusable, and semantically rich. These levels fit with the three main types of uses related to the different expected lives of CAD models.
- H4. The hierarchical levels of CAD quality are useful for defining strategies for quality assessment and control. Objective and quantifiable metrics can be defined to measure CAD models efficiently and reliably.

In this position paper, we justify the validity of the first three hypotheses but limit our discussion of the fourth hypothesis to a set of examples to point out its viability. Our classification: (1) clusters the six dimensions into three levels, which connect with the extensive literature on usability and reusability; (2) highlights that the higher levels cannot be tended to if the lower levels of quality have not been previously ensured, and (3) will enable the design and implementation of an algorithm that can automatically evaluate CAD models and be used to train machine learning systems. Finally, we anticipate that the framework developed in this work will also be applicable to CAD education and technical training. An approach to strategic CAD teaching that infuses a culture of quality from the

beginning can lead to better prepared and more productive CAD professionals, generating a positive impact on organizations. Workforce development and proper CAD training were identified as top responses to the design reuse challenges discussed in the Aberdeen report [25].

## 2 REVIEW

In this section we briefly review the context in which we intend to develop our framework and summarize the most relevant work. We conclude by highlighting the open problems in this area as a separate sub-section of the review section to emphasize the fact that the problem of scoring the quality of CAD models remains unsolved.

### 2.1 Context

The economic cost of low-quality models is significant. Inefficient modeling practices and dependency management typically result in models that are difficult to alter and require considerable amounts of rework [31], [36]. Informal evidence shows that most organizations do acknowledge the problem [7]. In many cases, however, companies assume that there are inherent inefficiencies in the processes that involve virtual models, and grudgingly accept the associated costs. Furthermore, firms are generally reluctant to openly discuss the prevalence of low-quality models in their organizations, which would require admitting inefficient business practices. Interestingly, the problem of parametric CAD model quality has received little attention from the research community.

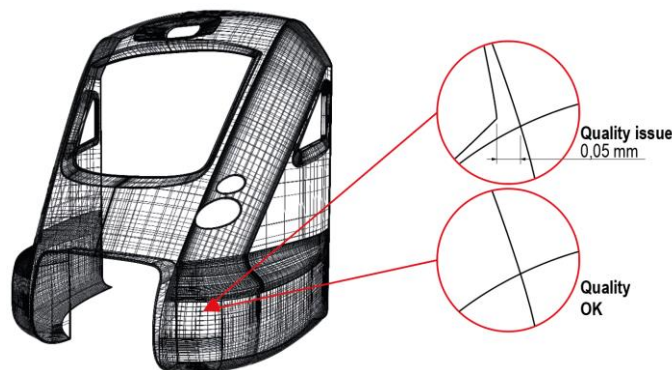

**Figure 1:** Quality failures are typically small in scale, which contributes to them going unnoticed if formal search and repair strategies are not applied.

Low CAD quality is the result of two correlated situations. First, education and training, both academic and professional, usually focus on the functionality of the software package but ignore the strategy. Authors agree that mastering the functionality of a CAD package is not sufficient to produce efficient CAD models; a strategic knowledge of the CAD tool is key to producing models that can be edited and reused [5,13,19]. Second, some large organizations have attempted to address CAD quality problems by developing internal modeling procedures, which guide designers and engineers in their modeling tasks. These types of documents are typically released for internal use and are often considered part of the organization's intellectual property. Therefore, their effectiveness and efficiency are difficult to measure and compare.

In terms of focus, academic approaches to quality issues have typically been error-centric (e.g., [21]), whereas enterprise approaches tend to be more concerned with good practices (e.g., what errors occur versus how they can be avoided or corrected). Regarding reach, approaches with limited scope have been evolving towards more extensive proposals, some of which attempt to cover all aspects of quality. As a result, this type of documentation may vary from a compilation of basic modeling guidelines to an intermediate level of style guides (which is the most frequent) to a full

modeling methodology. The existing documentation is very diverse. The most relevant example of publicly available modeling guidelines that were promoted to standards by private enterprises is the SASIG PDQ guideline and its German derivative VDA 4955 [41]., which are error-centric and limited to providing geometric and topological correctness criteria.

Donald LaCourse published some pioneer “Modeling Guidelines,” which were aimed at encouraging efficient modeling. The author considered (1) minimum modeling time, (2) model size and complexity classifications, and (3) clean modeling [28]. His proposal is relevant to study quality, as efficiency is one of its key objectives. Interestingly enough, some of LaCourse's criteria were disregarded in subsequent methodologies.

Very few examples of formal modeling methodologies are available in the public domain. The few that exist focus on solid modelings, such as the patent-protected horizontal modeling methodology [29], the resilient modeling strategy [20] (accessible through a fee), or explicit references modeling [7], [1]. Although it has been tested and confirmed that these methodologies provide a positive impact [10], there is significant room for improvement. In our view, the methods developed so far (such as [24] or [20]) are remarkable contributions but incomplete approaches (they focus on reusability while assuming that good conventional practices can trivially guarantee usability, yet mostly ignore the need for semantical richness). This problem has been further addressed by Aranburu et al. [5]. A method that considers the different dimensions of CAD quality has not yet been proposed. Additionally, to the best of our knowledge, no attempt has been made to use these methods to quantify the quality of CAD models (other than the weights suggested by Company et al. for their rubric [13]).

## 2.2 Related Work

Our framework of quality builds on the linguistic model developed by Contero et al. [12], which defined levels of quality by mimicking “the different levels and approaches that natural-language analysis uses, such as phonology (phonetics and sounds), morphology (forming words from more basic units that have meaning), syntax (forming sentences out of words), semantics (meanings of sentences obtained from words) and pragmatic (understanding how sentences are used).” In their proposal, morphology relates to the geometric and topological correctness of the CAD model, syntax evaluates the use of proper modeling conventions, and the semantic/pragmatic level considers the CAD model's capability for reusing and modification.

Gonzalez et al. [21] proposed a taxonomy that distinguishes between explicit and procedural models (also known as history-based models) and characterized morphologic, syntactic, and semantic errors for each type of model. In this paper, we focus exclusively on procedural models. Additionally, Gonzalez et al. [21] paired each level to a particular type of change: morphologic to simplification, syntactic to interoperability, and semantic to reuse.

Company et al. stated that CAD quality is a complex and multidimensional construct. Indeed, the authors defined the six main dimensions of procedural CAD quality [13]: (1) models are valid if they can be opened by suitable applications and do not contain errors or warnings; (2) models are complete if they include all the product aspects that are relevant for design purposes; (3) models are consistent if they are robust (changes do not produce unexpected failures) and flexible (allow many changes); (4) models are concise as long as they do not contain repetitive information or operations, do not contain fragmented information or operations and use high-level modeling operations when available; (5) models are clear if they are simple, easy to understand (an observer can easily explain the model), and (6) models capture design intent as long as they are effective (convey design intent), efficacious (convey more design intent than other modeling processes), and efficient (it is worth modeling in this particular manner to convey design intent, as the same design intent could not be conveyed in a simpler manner).

## 2.3 Open Problems

Current quality checkers for CAD models barely assess the validity of models. Available commercial Model Quality Testing (MQT) systems provide basic automatic mechanisms to identify the geometric

and topological errors described by standards such as SASIG PQD 2.1 and VDA 4955. However, aspects related to the verification and effective implementation of design intent, as well as measuring the ability of a 3D model to be reused, adapted, and modified, are not supported [21].

Many academic studies encourage consistency in CAD models [23]. However, a recent study demonstrated that sketch consistency in procedural CAD models (an aspect of the broader dimension of consistency that results from the best practice in CAD that encourages fully constrained sketches) is unusual. In a recent study, researchers reported that only 2.5% of the sketches analyzed on 2 million models created with PTC Onshape from 2015 to 2020 were completely constrained [42]. There are also studies on conciseness and clarity aimed at ensuring reusability [3,20,24,34]. However, these dimensions of CAD quality have received comparatively less attention from the industry.

The design intent is an open problem in and of itself. Some recent research activity still focuses on determining what design intent is and how CAD models convey design intent. Regarding the definition, Otey et al. [37] refer to STEP part 108, "intentions of the designer of a model with regard to how it may be instantiated or modified." This definition fits better with our vision than the common alternative, the "CAD model's anticipated behavior when altered." Since our goal is measuring the extent or level of design intent in a model, in our view, "behavior" focuses on a vision of the problem that makes it less quantifiable than when classified as "intentions." In this regard, we are deliberately diverging from the common approach that equates design intent to reusability. We understand reusability as the possibility for reuse, whereas design intent focuses on facilitating reuse. In other words, there is a difference between having the possibility to redesign a model and working with a model that lends itself to redesign.

Authors Mandorli et al. [33] assume that design intent is related to the readability, alterability, and usability of CAD models. They then upgraded the traditional method of communicating design intent with functional dimensioning in mechanical drawings by advocating for explicit 3D functional dimensioning [33]. Ramos et al. advocate for a strategic knowledge-learning methodology where easiness of modification and reusing are two key aspects that improve design intent [40]. They properly fragment the part into features and leverage adaptive expertise to improve the results in relation to design intent [39]. The authors conclude that "Design intent must be introduced in CAD from the very beginning so that all the models are flexible and robust" [38]. Company et al. argue that a suitable selection of geometric constraints that operate within and between features facilitates reuse while retaining their design intent when modified [14]. Kyratzi and Azariadis further argued that sketches in parametric CAD models conveyed the design intent through suitably constrained sketches and described a procedure for automatic recognition of a set of design intentions during the sketching process [26]. Finally, many authors focus on the differences between declarative, procedural, and strategic knowledge [16,17,19], which resonate with our proposed levels that measure whether CAD models are usable, reusable, and semantically rich.

### 3 A HIERARCHICAL MULTILEVEL FRAMEWORK

We propose a quality framework that builds on the levels of quality described in the study by Contero et al. [12] and enriches them with a procedure to verify the six dimensions of quality by Company et al. [13]. The procedure is detailed using a checklist or rubric. In this paper, we advocate clustering the six quality dimensions into three main levels so we can enable measurements on whether CAD models are (1) usable, (2) reusable, and (3) semantically rich. In our view, usability encompasses validity and completeness, reusability characteristics include consistency and conciseness, and a semantic-rich model implies clarity and the ability to convey design intent.

Three arguments support our proposal. First, we understand that previous guidelines, style guides, and modeling methodologies focus on the "how" and not the "what." Certainly, these instruments assume that the objective is for the models to have quality, but they begin to describe procedures without having previously analyzed the concept of quality meticulously. In doing that, they take the part for the whole. The numerous (and often difficult to access) modeling guidelines, style guides, and formal methodologies tend to focus on usability, i.e., "how" the resources of the



CAD applications may be used to prevent errors and ensure that standards are met. Current proposals take the part (reusability) for the whole (quality). Furthermore, they have a limited vision of reusability itself, as they emphasize strategies that favor direct and easy editing of anticipated changes of models. All of these proposals ignore quality faults at the highest hierarchical level, so the resulting models are not "enriched," which means they are not useful for high-level design tasks, such as the automatic or semi-automatic exploration of design spaces [2].

Second, we are in search of a framework that enables the quantitative measurement of the quality of CAD models. The hierarchical organization of the three proposed levels naturally aligns with an incremental quantification of quality. For example, models that are usable could be easily ranked as "acceptable," models that are also reusable as "good," and models that, in addition to being usable are reusable, are semantically rich as "excellent." Here, we note the trade-offs between competing criteria, such as the required balance between robustness and flexibility regarding consistency or the less obvious conflict between conciseness and simplicity. These types of trade-offs are at the core of the design process, so designers are used to finding reasonable solutions. The trade-offs also imply that any quality measurement approach should find the right balance when quantifying the level of achievement of opposite criteria. For instance, a profile is robust if it is fully constrained and it is flexible if shape, size, position, and orientation are fixed independently. The profile is consistent if both properties are simultaneously achieved.

Finally, the fact that quality criteria depend on the expected useful life of the model cannot be ignored. The same level of quality is not necessarily required for short-life models as for long-life models. For example, short-lived models may not require the application of sophisticated modeling methodologies, or at least not to the same extent as models with a longer useful life. Indeed, one can argue that sometimes it may even be counterproductive to spend too much time trying to determine the optimal modeling strategy for a particular model that will not be long-lived. That said, nearly all CAD models today are built and evaluated as if they were short-lived, which is clearly detrimental to the MBE paradigm.

In this context, a complete methodology that includes high-level aspects of model quality can be beneficial, particularly for complex and/or collaborative designs. More specifically, a hierarchical structure of quality levels can be an effective solution to accommodate increasing quality requirements based on the expected life of the models. We propose that short-lived models of routine designs be evaluated only up to the first level of quality (i.e., they must be usable), whereas models that will be carriers of information throughout the—perhaps collaborative—life cycle of a product must also be reusable (in addition to being usable), and capable of evolving into digital twins. Finally, models that are going to be used to share information (annotated models [15]) and/or explore the design space must also be semantically rich.

Company et al. [13] stated that models are clear if, in addition to being simple and easy to understand, they also maximize compatibility with other CAD formats (i.e., they are readable and usable by other applications). In principle, this is a debatable feature. It can be argued that it has to do with the quality of the translators implemented by the system in question. It should be noted, however, that a bad model can sometimes make it difficult for a good translator. On the other hand, this can also be an example of unnecessarily high quality if it is assumed that the model will never have to be exported to any other format.

A fundamental reflection about hierarchical levels is that the selection of the necessary level of quality can be challenging. Generally, it is better to overdo it than to fall short because quality can be extremely difficult (or impossible) to improve after the model has been created. As concluded by the Aberdeen report, the most successful strategy to engage in design reuse is to "integrate preparation and verification of designs for reuse into the design phase" [25].

Three driving ideas summarize our proposal: (1) reusability is not attainable without previously attaining usability. It makes no sense to strive to produce semantically rich CAD models if they cannot be reused; (2) the longer the expected lifecycle of the model, the higher the need for full-quality models; and (3) collaborative designs are more likely to demand full quality CAD models than local in-house developments. The relevance of each level is illustrated in Figure 2.

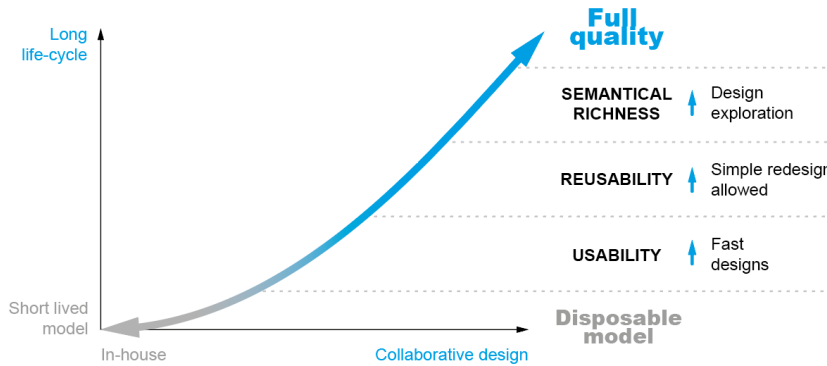

**Figure 2:** The required level of quality depends on the expected life of the model and whether the design is in-house or collaborative.

#### 4 CHECKLIST FOR QUALITY LEVELS

A manual checklist was developed to demonstrate that model quality can be measured using the proposed hierarchical multilevel framework. The proposed checklist can also be automated (at least partly), as briefly described in the explanations. The development of methods that are automatable is important but challenging. Although the use of checker technologies is a successful strategy to ensure the quality of models [25], model quality criteria for procedural models as supported by current model quality testing tools (some of them with repair capabilities) are still limited. Specifically, they are biased toward interoperability issues and ignore reusability and semantical richness [21]. A recent contribution was published by Aranburu et al. [5].

##### 4.1 Usability

Models are valid if they are retrievable (i.e., they can be found and opened), free of errors, and compatible with the application. Models are complete if they replicate the shape and size of the object they represent. We recommend the clustering of validity and completeness into the entry level quality criteria.

A model is usable if all the items in the following checklist are satisfied. For formative purposes, the checklist may be used as a rubric, and suitable weighted scores may be assigned to their items to guide and encourage learners to discover and correct the quality errors they make. Nevertheless, to measure the overall quality of an industrial CAD model, usability should be considered a pass-fail criterion, regardless of whether the model is local or shared, or the expected life is long or short.

##### 4.1.1 Valid

The model is retrievable if the following requirements are satisfied:

- The file is in the expected folder, meets the organization's naming criteria, or, alternatively, is labeled with a name that describes the shape and/or the function of the part (Figure 2).

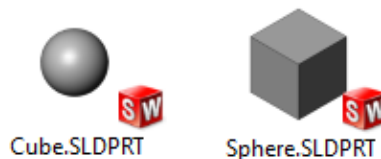

**Figure 2:** Trivial examples of incorrect file naming.

- The file reopens with the suitable CAD application.

The model is error-free if the following requirements are satisfied:

- The model tree is free from error messages.
- The file re-opens in a neutral state (the model tree is available, and no command is in progress).

We note that the file must re-open in the same CAD application in all cases, but it must also re-open (or “exchange to”) different CAD applications when interoperability is mandatory (see VDA 4950, for example).

The model is valid if the previous requirements are satisfied. Implementing an automatic tool to check that the model has no errors and is stored in a neutral state seems straightforward and achievable. However, it is more difficult to check the file name and location automatically unless strict naming practices are enforced or a PLM system is used to manage the files. The detection of errors that cannot be detected by the geometric engine remains an open problem. A list of these failures is available in [21].

#### 4.1.2 Complete

Measuring completeness depends greatly on whether the quality is compared against a ground truth model or a set of design specifications. The former is a typical scenario in training and evaluation, where a ground truth model provided by the instructor enables the quality evaluation process. The latter is a much more challenging situation that is common in the detailed design stages of industrial products. We currently suggest a guided check. The model is complete if the following requirements are satisfied:

- The model is of the intended type (solid, hollow shell, surface).
- The different views of the model match the intended shape.
- The dimensions of the model match the intended sizes of the object (dimensional units must also be reviewed).

Completeness depends on the scope of the model since some simplifications may be desirable or even required for certain purposes. Therefore, we use completeness in the restrictive sense of desired completeness. A problem that remains unsolved involves determining the scenarios where simplifications are acceptable. For example, can a model with cosmetic threads be considered complete, or are geometric threads always required? Being able to determine whether a model is complete automatically is challenging due to the very nature of the design process, where new forms and geometries are constantly explored. The intellectual assessment of a designer is difficult to replace with an automated verification process. Yet, the undesired changes in the typology of the model, as well as those errors in the González catalog [21] that affect shape, are examples of aspects that can be verified. A classic example of an incomplete model that can easily go unnoticed is the hollow shell that involuntarily replaces a solid when an open profile is mistakenly used to close the sketch outline (Figure 3).

The gap between the rib and the cylindrical feature in the model shown in Figure 4 is the result of an incorrect modeling process that produces a low-quality model in terms of completeness. Current model quality checkers are generally able to detect many of these failures.

## 4.2 Reusability

The intermediate level of quality can be reached by clustering consistency and conciseness. Consequently, we note that the properties that need to be checked may be somewhat contradictory, as too much consistency can prevent conciseness. It should also be noted that reusability is generally not necessary for short-lived models. Therefore, it may not always be necessary to check for reusability or expect models to pass or fail reusability verifications. Instead, a level of reusability can



be determined by scoring all the criteria met by the model. Models with a low level of reusability should never be accepted in complex, long-term, collaborative designs.

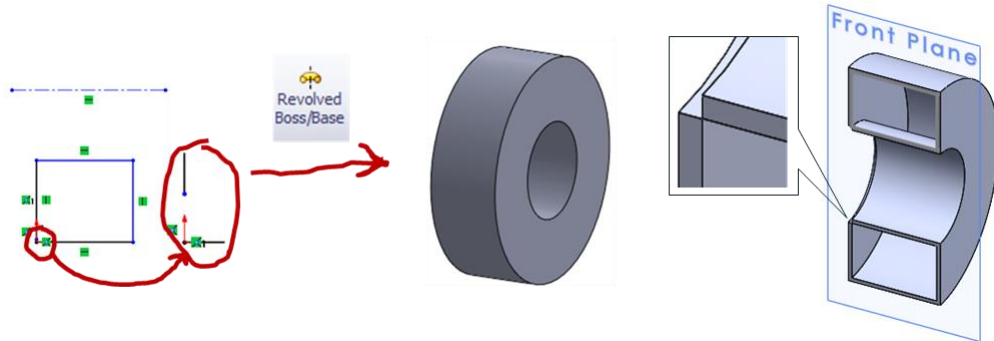

**Figure 3:** Hollow shell instead of a solid.

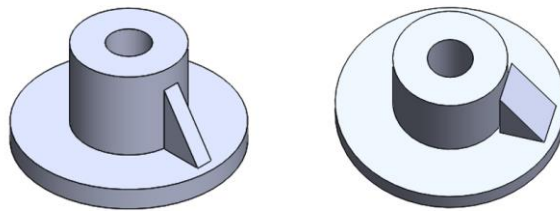

**Figure 4:** The gap between the rib and the cylindrical feature (left) is only noticeable after increasing the rib thickness and changing the point of view (right).

Reusability checking is proposed at three sublevels, based on the actions aimed at improving profiles (also known as sketches), datums (also known as reference elements), or modeling operations (also called features or modeling features), which are the basic components in a Constructive Solid Geometry approach for building parametric and procedural CAD models.

#### 4.2.1 Consistent

A model is consistent if the following requirements are satisfied:

- The lines of the sketches define suitable profiles (i.e., closed profiles for sweeping solids).
- Sketches have no missing or redundant constraints.
- The relationships between datums and model features ensure that the model is properly located and oriented.
- The relationships between model features ensure that multiple solid bodies are not created unintentionally and surface patches are properly stitched, guaranteeing the required level of continuity.

As stated in [13], consistency expresses the goal of allowing the safe exploration of alternative solutions while maintaining valid geometries. Consistent models should not fail as a result of editing tasks.

The first step to achieving consistency involves producing consistent profiles (which are the sketched contours used in sweeping operations). Consistent profiles are both robust and flexible. Profiles are robust if they are fully constrained (which is a metric included by default in many CAD systems). In our view, robust profiles must also (1) not contain any partially or fully overlapping

lines, (2) not contain any segmented lines, and (3) contain only fully constrained lines. These qualities can be measured through the following metrics: the number of unconstrained degrees of freedom and the number of overlapping, segmented, or dangling lines, which are inverse metrics of the robustness of the profiles.

Note that non-containing any partially or fully overlapping lines or any segmented lines are considered reusability issues because whether they affect usability, reusability, or both depends on the particular case and the context. For example, a square drawn with five sides, two of which are collinear and have a combined length equal to that of the other three sides, is not a usability problem because the model that will be obtained when sweeping will be correct. However, it is a reusability problem because changing the size of the square will cause the "false" side to behave in an unpredictable manner.

Likewise, profiles are flexible if their constraints (1) allow for local changes while (2) prevent local changes from causing undesired alterations or errors. Building on González et al. [22], we propose the use of the number of fixed constraints as an inverse metric of the flexibility of the profiles.

Models are consistently linked to datums if they are suitably linked to the main reference system (i.e., the model is not created upside down or arbitrarily displaced/rotated from the center of the scene, as the table in Figure 5), and the structure, skeleton or scaffold of the part is made of suitable datums. Finding a suitable placement for a model, however, requires an in-depth analysis of the shape to detect complex properties such as symmetry planes [32]).

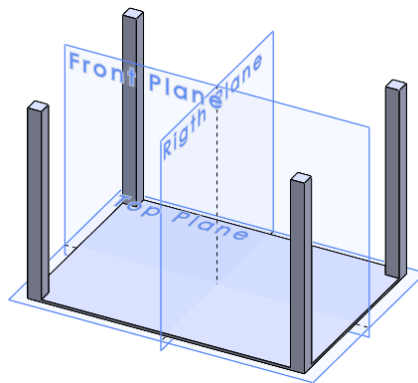

**Figure 5:** Table modeled upside down.

Finally, modeling operations are consistent if (1) functional elements are defined by independent modeling operations and (2) the parent/child relations in the model tree are free of unnecessary dependencies. A future metric could leverage automatic feature recognition strategies (see [18] and [35]) to compare the automatically detected features with those on the actual model tree. Another metric could use complexity metrics of the acyclic digraphs that represent dependencies between features [8].

#### 4.2.2 Concise

A model is concise if the following requirements are satisfied:

- Sketches do not include missing or redundant lines.
- Sketches do not include missing or redundant constraints.
- There are no missing or redundant data.
- The model tree does not have any missing or redundant features.

Concise models do not include irrelevant or repetitive information or procedures. At a profile level, conciseness means that profiles do not contain repetitive or fragmented constraints. For instance, four perpendicularity constraints between consecutive sides are redundant when applying constraints

to a square shape. Two lines that are mutually perpendicular, while one of them is also horizontal (i.e., parallel to the X axis) and the other is vertical (i.e., parallel to the Y axis), are redundantly constrained. Most CAD applications can detect the excess of constraints only if they are incompatible with each other but often ignore redundant constraints. Therefore, a new metric to track the number of redundant constraints is required.

At a datum level, conciseness implies that pattern operations (e.g., translate-and-repeat, rotate-and-repeat), as well as modeling operations of symmetry, are used whenever possible to build the model. The problem when trying to measure model conciseness based on the efficient use of data is the lack of a ground truth that can inform about the optimal number of patterns for the model.

A common conciseness metric for modeling operations is the total number of operations employed to create a certain part [11]. However, the metric favors minimization (which contradicts clarity) and relies on an existing benchmark. A balance must be found because excess in promoting conciseness may compromise clarity. Furthermore, the metric could only be extended to determine the quality of a non-benchmarked part if the optimal number of modeling operations is calculated in advance (for example, by using automatic feature recognition strategies, which are unfortunately still far from successfully providing consistent solutions).

Alternative strategies are readily available. Operations that add material to a volume that was already filled or remove material from a hollow volume are likely repetitive. We propose a metric to measure the percentage of the volume added or removed by a new modeling operation that was already added or removed in the previous model.

### 4.3 Semantic Richness

Expanding on the semantic/pragmatic level of the linguistic model by Contero et al. [12], we define "semantic richness" as the set of attributes in a CAD model that help communicate relevant design information beyond shape and size to all the stakeholders that need to interact with the model.

A common misconception in many companies is that a well-documented CAD model may reveal certain know-how to stakeholders. Therefore, semantically rich CAD models may potentially expose confidential information. Consequently, the company's know-how is never documented; it is only preserved in the minds of the designers. Therefore, when a designer leaves the company or retires, the organization loses part of the intellectual capital. The alternative is to generate semantically rich CAD models, protect them from unauthorized use, and share only the filtered versions that are necessary at a particular time.

Similarly to the reusability criteria, checking for semantic richness may not always be required. Semantic richness is only useful to preserve know-how, improve communication between stakeholders in complex collaborative projects, as well as to provide models for design space exploration tasks. A level of semantic richness is measured by scoring all the relevant criteria met by the model. Models with a low level of semantic richness should not be accepted in the scenarios described above.

#### 4.3.1 Clarity

The model is clear if the following requirements are met successfully:

- Compatible and standard constraints have been prioritized.
- Explicit data have been prioritized.
- Explicit datums and modeling operations have been labeled in the model tree to emphasize their function as opposed to how they were constructed.
- Related datums and modeling operations are grouped in the model tree to emphasize parent-child relationships.
- Compatible and semantically rich modeling operations have been prioritized.

Models are clear if they are easy to understand (a viewer can easily explain the model) and enable design exploration. At a profile level, clarity implies that compatible and standard constraints (i.e., those that are common and shared by different CAD applications) are preferred. In the absence of

constraints with standardized behavior, we suggest prioritizing those that have at least one standardized conversion between formats.

At a datum level, clarity implies that explicit datums are preferred over datums created “on the fly.”

At a feature level, modeling operations are clear if they are labeled in the modeling tree to emphasize their function instead of how they were built. In addition, related modeling operations should be grouped in the model tree to emphasize parent-child relationships Figure 6). Once again, there is a lack of ground truth that can inform us about the optimal names and number of folders in a model. However, a number of indirect metrics and indicators can be used for unclear models: (1) whether the default names of the modeling operations have been changed, (2) whether the folders used to group modeling operations have been defined, and (3) whether secondary modeling operations such as fillets and chamfers are placed at the end of the model tree.

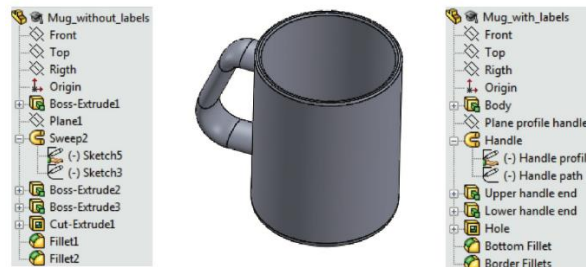

**Figure 6:** Proper labeling of modeling operations as a simple way to convey design intent. Proper naming (left tree) vs. default naming (right tree) ([37]).

Additionally, the number of intermediate stages in the model tree where a final single solid model becomes multi-body can be calculated to identify an unclear modeling strategy that builds a “patched” model.

The number of features performed with specialized modeling operations (such as hole features vs. negative extrusions, as shown in Figure 7) can also be used as an indirect metric. It should be noted, however, that specialized features have been historically considered prone to produce less compatible CAD models, and thus should be consciously avoided when compatibility is a must [28].

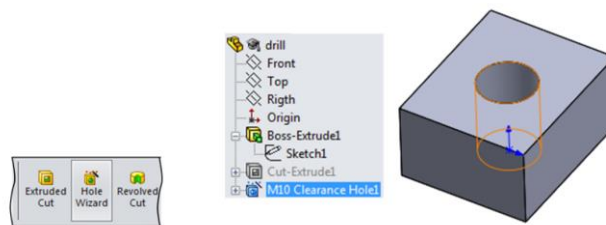

**Figure 7:** A hole as a manufacturing feature.

Finally, the most generic and simple modeling operations that allow the creation of the desired geometry must be prioritized (Figure 8). Although this point is relatively straightforward or human, it becomes excessively ambiguous to be translated into a metric.

#### 4.3.2 Design intent

In this paper, we adopted the definition of design intent provided in STEP part 108: “intentions of the designer of a model with regard to how it may be instantiated or modified.” In other words, the

CAD model must provide information, explicit or implicit, to help future users understand why the model was created in a particular manner, what its expected function is, and what types of changes were foreseen as acceptable.

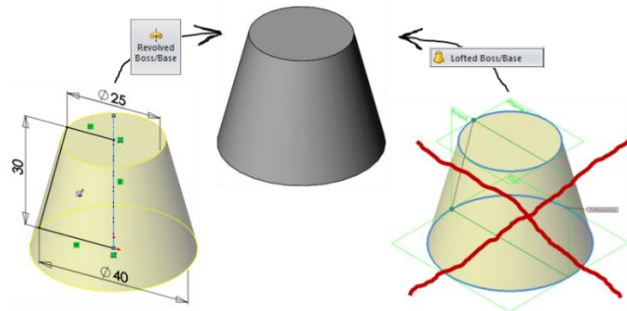

**Figure 8:** Simple (left) vs. complex sweep (right).

Yet the multifaceted concept of design intent is somewhat cross-cutting, as it permeates all aspects of quality. Our vision is to strictly value as design intent those aspects that contribute the most to obtaining semantically rich CAD models. Therefore, a model conveys design intent if the following requirements are satisfied:

- The model “effectively” conveys suitable information about the design fundamentals, function, and alteration limits of the product.
- The model “efficaciously” conveys more information than the potential alternatives.
- The model “efficiently” requires less effort to convey the same information than the potential alternatives.

In terms of assessment, we should measure whether the modeling process is effective in conveying the right information about a model’s design fundamentals, function, and alteration limits. Additionally, we should measure whether the modeling process conveys the information in a correct manner: the modeling process conveys more relevant design information than other modeling processes (i.e., it is efficacious in conveying information on why it was built in a particular manner), and the modeling process requires less effort than others to convey the same design and re-design information (i.e., it is efficient). We consider effectiveness, efficacy, and efficiency as the properties that all information that enriches the model must have to enable tasks that go beyond reusability. Therefore, they measure the ease of reuse, not the possibility of reuse. In other words, we examine the information that brings out affordances instead of the information that allows for affordability.

However, these metrics are difficult to capture and assess. There is no “explicit” instrument to communicate design intent, making it difficult to verify whether the CAD model actually conforms to the design intent. Some authors have suggested leveraging the critical dimensions in the model [33] or employing a type of explicit annotations [15]. Simple strategies that are commonly recommended to facilitate the capture and communication of design intent include reordering the model tree so that it reads like a recipe for the model (revealing the function of each feature, the construction process of the part, etc.) and avoiding the transfer and conversion of dimensions into geometric constraints. Therefore, we can quantify some merits that correlate with the semantic richness of the model.

To check for model efficiency, we can iteratively make alterations to the geometry to determine the number of times the model fails. The ranges of variation can be increased if small changes do not cause the model to fail [2]. This type of check will only filter models of very low quality, since altered models may lose their design intent but not necessarily fail to rebuild. For example, a symmetric part may be changed and rebuilt without errors but may lose its symmetrical properties because of an ineffective constraining scheme that does not enforce symmetry. Therefore, we mainly suggest it as a demonstrator of future metrics.

Finally, auxiliary elements in the model can temporarily be suppressed to determine whether the result is reasonable and error-free. For instance, in an inefficient model, certain main elements may become suppressed after suppressing rounds and fillets.

## 5 CONCLUSIONS

The premise of this paper is the well-known but often ignored fact that low-quality CAD models have a significant negative financial impact on the enterprise. Little literature exists on this problem because organizations are generally reluctant to openly discuss the prevalence of low-quality models in their workflows, as it would require admitting to inefficient business practices.

Some formal modeling methodologies have been proposed to mitigate the aforementioned problems, most notably horizontal modeling, explicit references modeling, and resilient modeling. We have argued that current modeling methodologies ignore high-semantic quality concerns and are not sufficiently flexible to accommodate quality requirements for each model's expected life. In this position paper, we proposed a hierarchical multilevel framework of quality aimed at ensuring that CAD models are usable, reusable, and semantically rich. A manual checklist demonstrates that the quality of a CAD model can be measured by using the hierarchical multilevel framework. As part of our future developments, we plan to automate the checklist, provided that a full set of quantifiable metrics can be defined.

The fact that formal modeling methodologies are not widely adopted suggests that they are inefficient or not fully understood. We anticipate that design-based research (DBR) can help us gain a better understanding of why and how CAD quality works by developing interventions that support trainees in acquiring these skills.

## 6 ACKNOWLEDGEMENTS

This work was supported by project PID2022-137254OB-I00, funded by MCIN/AEI/10.13039/501100011033/FEDER, UE.

*Pedro Company*, <https://orcid.org/0000-0001-6399-4717>

*Manuel Contero*, <https://orcid.org/0000-0002-6081-9988>

*Jorge D. Camba*, <https://orcid.org/0000-0001-5384-3253>

*Aritz Aranburu*, <https://orcid.org/0000-0001-6022-1153>

*Daniel Justel*, <https://orcid.org/0000-0002-8302-4862>

## REFERENCES

- [1] Aranburu, A.; Camba, J.D.; Justel D.; Contero, M.: An Improved Explicit Reference Modeling Methodology for Parametric Design, *Computer-Aided Design*, 161, 2023, 103541. <https://doi.org/10.1016/J.CAD.2023.103541>
- [2] Aranburu, A.; Cotillas, J.; Justel, D.; Contero, M.; Camba, J.D.: How Do the Modeling Strategy Influence Design Optimization and the Automatic Generation of Parametric Geometry Variations?, *Computer-Aided Design*, 151, 2022, 103364. <https://doi.org/10.1016/j.cad.2022.103364>
- [3] Aranburu A.; Justel D.; Angulo I.: Reusability and flexibility in parametric surface-based models: A review of modeling strategies, *Computer-Aided Design and Applications*, 18(4), 2021, 864–874. <https://doi.org/10.14733/cadaps.2021.864-874>
- [4] Aranburu, A.; Justel, D.; Contero, M.; Camba, J.D.: Geometric Variability in Parametric 3D Models: Implications for Engineering Design. 32nd CIRP DESIGN Conference, Paris, FRANCE, 2022, 383–388. <https://doi.org/10.1016/j.procir.2022.05.266>
- [5] Aranburu A.; Justel D.; Contero M.; Company P.; Camba J.D.: Are we Using Effective Modeling Strategies in Parametric Associative CAD? CAD'24 Proceedings, Eger, HUNGARY 2023, 115-120. <https://doi.org/10.14733/cadconfP.2024.115-120>



- [6] Besharati-Foumani H.; Lohtander M.; Varis J.: Fundamentals and new achievements in feature-based modeling, a review. *Procedia Manufacturing*, 51, 2020, 998–1004.
- [7] Bodein, Y.; Rose, B.; Caillaud, E.: Explicit reference modeling methodology in parametric CAD system. *Computers in Industry*, 65(1), 2014, 136–147. <https://doi.org/10.1016/j.compind.2013.08.004>
- [8] Camba, J. D.; Contero, M.: Improved representation of dependencies in feature-based parametric CAD models using acyclic digraphs, In *GRAPP2015 Proceedings of the 10th International Conference on Computer Graphics Theory and Applications*, 2015, 16–25. <https://doi.org/10.5220/0005261500160025>
- [9] Camba J.D.; Contero, M.; Company, P.; Hartman, N.: The cost of change in parametric modeling: A roadmap, *Computer-Aided Design and Applications*, 18(3), 2021, 634–643. <https://doi.org/10.14733/cadaps.2021.634-643>
- [10] Camba J.D.; Contero, M.; Company, P.: Parametric CAD Modeling: An Analysis of Strategies for Design Reusability, *Computer-Aided Design*, 63, 2016, 18–31. <https://doi.org/10.1016/j.cad.2016.01.003>
- [11] Camba, J. D.; Contero, M.; Pérez-López, D.; Company, P.: A database framework for the characterization and classification of parametric models based on complexity metrics to support data analytics. *International Manufacturing Science and Engineering Conference, American Society of Mechanical Engineers*, 58745, 2019, V001T02A007. <https://doi.org/10.1115/MSEC2019-2812>
- [12] Contero, M.; Company, P.; Vila, C.; Aleixos, N.: Product data quality and collaborative engineering. *IEEE Computer Graphics and Applications*, 22(3), 2002, 32–42. <https://doi.org/10.1109/MCG.2002.999786>
- [13] Company, P.; Contero, M.; Otey, J.; Plumed, R.: Approach for developing coordinated rubrics to convey quality criteria in MCAD training, *Computer Aided Design*, 63, 2015, 101–117. <https://doi.org/10.1016/j.cad.2014.10.001>
- [14] Company P.; Naya F.; Contero M.; and Camba J.D.: On the role of geometric constraints to support design intent communication and model reusability, *Computer-Aided Design and Applications*, 17(1), 2020, 61–76. <https://doi.org/10.14733/cadaps.2020.61-76>
- [15] Company P.; Camba J.D.; Patalano S.; Vitolo F.; Lanzotti A.: A Functional Classification of Text Annotations for Engineering Design, *Computer-Aided Design*, 158, 2023, 103486. <https://doi.org/10.1016/j.cad.2023.103486>
- [16] Daud M.F.; Taib J.M.; Shariffudin R.S.: Assessing mechanical engineering undergraduates' conceptual knowledge in three-dimensional computer-aided design (3D CAD). *Procedia – Social and Behavioral Sciences*, 56, 2012, 1–11. <https://doi.org/10.1016/j.sbspro.2012.09.626>
- [17] Delahunty T.; Seery N.; Dunbar R.; Ryan M.: An exploration of the variables contributing to graphical education students' CAD modelling capability, *International Journal of Technology and Design Education*, 30, 2020, 389–411. <https://doi.org/10.1007/s10798-019-09503-x>
- [18] Fayolle P.A.; Friedrich M.: A Survey of Methods for Converting Unstructured Data to CSG Models, *Computer-Aided Design*, 168, 2024, 103655. <https://doi.org/10.1016/j.cad.2023.103655>
- [19] Garikano X.; Garmendia M.; Manso A.P.; Solaberrieta E.: Strategic knowledge-based approach for CAD modelling learning, *International Journal of Technology and Design Education*, 29(4), 2019, 947–959. <https://doi.org/10.1007/S10798-018-9472-1>
- [20] Gebhard R.: A Resilient Modeling Strategy, 2022. Available at <https://learnrms.com>.
- [21] González-Lluch C.; Company P.; Contero M.; Camba J.D.; and Plumed R.: A Survey on 3D CAD model quality assurance and testing tools. *Computer-Aided Design*, 83, 2017, 64–79. <https://doi.org/10.1016/j.cad.2016.10.003>
- [22] González-Lluch C.; Company P.; Contero M.; Pérez-López D.; Camba J.D.: On the effects of the fixed geometric constraint in 2D profiles on the reusability of parametric 3D CAD models, *International Journal of Technology and Design Education*, 29(4), 2018, 821–841. <https://doi.org/10.1007/s10798-018-9458-z>

- [23] González-Lluch C.; Plumed R.; Pérez-López D.; Company P.; Contero M, and Camba J.D.: A Constraint Redundancy Elimination Strategy to Improve Design Reuse in Parametric Modeling, *Computers in Industry*, 129, 2021, 103460. <https://doi.org/10.1016/j.compind.2021.103460>
- [24] Herron J.B.: *Re-Use Your CAD: The Model-Based CAD Handbook*, Independently published, 2021, ISBN-13: 979-8597987880.
- [25] Jackson C.; Buxton M.: *The design reuse benchmark report: seizing the opportunity to shorten product development*, Aberdeen Group, Boston, 2017.
- [26] Kyratzi S.; Azariadis P.: A constraint-based framework to recognize design intent during sketching in parametric environments, *Computer-Aided Design and Applications* 18(3), 2021, 545–560. <https://doi.org/10.14733/cadaps.2021.545-560>
- [27] Kitsios, V.; Haslauer, R.: 3-D Master for Digitalized Product and Production Development. *ATZ Production Worldwide* 6, 2019, 20–25. <https://doi.org/10.1007/s38312-019-0047-2>
- [28] LaCourse D.E.: *Handbook of Solid Modeling*, McGraw-Hill, 1995. ISBN-13: 978-0070357884.
- [29] Landers D.M.; Khurana P.: Horizontally-structured CAD/CAM modeling for virtual concurrent product and process design, US Patent 6,775,581, 2004.
- [30] Likuchi Y.; Hiraoka H.; Otaka A.; Tanaka F.; Kobayashi K.G.; Soma A.: PDQ (Product Data Quality): Representation of Data Quality for Product Data and Specifically for Shape Data. *Journal of Computing and Information Science in Engineering*, 10, 2010, 021003-1. <https://doi.org/10.1115/1.3402615>
- [31] Lindsay A.; Paterson A.; Graham I.: Identifying and quantifying inefficiencies within industrial parametric CAD models. In *Advances in Manufacturing Technology XXXII: Proceedings of the 16th International Conference on Manufacturing Research*, 8, 2018, 227).
- [32] Li M.; Langbein F. C.; Martin R. R.: Detecting design intent in approximate CAD models using symmetry, *Computer-Aided Design*, 42(3), 2010, 183-201.
- [33] Mandorli F.; Otto H.E.; Raffaelli R.: Explicit 3D functional dimensioning to support design intent representation and robust model alteration, *Computer-Aided Design and Applications*, 13(1), 2016, 108–123. <http://dx.doi.org/10.1080/16864360.2015.1059201>
- [34] Nerents T.B.; Ebro M.; Nielsen M.; Eifler T.; Nielsen K.L.: Exploring barriers for the use of FEA-based variation simulation in industrial development practice. *Design Science*, 7, 2021, e21. <https://doi.org/10.1017/dsj.2021.21>
- [35] Niu Z.; Martin R.R.; Langbein F.C.; Sabin M.A.: Rapidly finding CAD features using database optimization. *Computer-Aided Design* 69, 2015, 35-50. <https://doi.org/10.1016/j.cad.2015.08.001>
- [36] Ostrosi E.; Stjepandić J.; Tomasić Ž.: Robust CAD modeling: concepts and principles for industrial applications, In *Transdisciplinary Engineering for Complex Socio-technical Systems–Real-life Applications*, 2020, 612–621. IOS Press.
- [37] Otey J.; Company P.; Contero M.; Camba J.D.: Revisiting the design intent concept in the context of mechanical CAD education, *Computer-Aided Design and Applications*, 15(1), 2018, 47–60. <https://doi.org/10.1080/16864360.2017.1353733>
- [38] Ramos B.; Melgosa C.: CAD learning in Mechanical Engineering at universities, *Computer-Aided Design & Applications*, 18(1), 2021, 24-41.
- [39] Ramos B.; Melgosa C.; Castrillo G.: The importance of adaptive expertise in CAD learning: maintaining design intent, *Journal of Engineering Design*, 29(10), 2018, 569–595.
- [40] Ramos B.; Melgosa C.; Zamora R.: Learning CAD at university through summaries of the rules of design intent, *Int. Journal of Technology and Design Education*, 27(3), 2017, 481–498.
- [41] SASIG– Product Data Quality for the Global Automotive Industry. ISO/PAS 26183:2006. Norm Withdrawal Date: 16 June 2014
- [42] Seff A.; Ovadia, Y.; Zhou W, Adams, R. P.: Sketchgraphs: A large-scale dataset for modeling relational geometry in computer-aided design, arXiv preprint arXiv:2007.08506, 2020. <https://doi.org/10.48550/arXiv.2007.08506>
- [43] Shah J. J.; Mäntylä M.: *Parametric and feature-based CAD/CAM: concepts, techniques, and applications*, John Wiley & Sons, 1995.