	<p>EXPERIMENTAL COMPARATIVE STUDY BETWEEN MPPT, HYBRID P&O AND FUZZY CONTROL FOR A SMALL WIND TURBINE APPLICATION</p>	<p>ENERGY TECHNOLOGY</p>
<p>RESEARCH ARTICLE</p>	<p>Marlon M. Gallo, Eneko Mola, Ignacio Muguruza, Aitzol Ugartemendia, Gonzalo Abad, David Cabezuolo.</p>	<p>Non-conventional energy sources</p>

EXPERIMENTAL COMPARATIVE STUDY BETWEEN MPPT, HYBRID P&O AND FUZZY CONTROL FOR A SMALL WIND TURBINE APPLICATION

ESTUDIO COMPARATIVO EXPERIMENTAL ENTRE MPPT, P&O HÍBRIDO Y UN CONTROL BASADO EN LÓGICA DIFUSA PARA UNA COMPARACIÓN EXPERIMENTAL DE MINIEÓLICA

Marlon M. Gallo¹, Eneko Mola¹, Ignacio Muguruza¹, Aitzol Ugartemendia¹, Gonzalo Abad¹, David Cabezuolo¹.

¹Mondragon University, Electronic and Computer Science Department, Loramendi 4, 20500 Mondragon, Basque Country, Spain.

Received: 27/Jul/2021- Revised: 09/Sep/2021 Accepted: 04/Nov/2021- DOI: <https://doi.org/10.6036/ES10295>

TO CITE THIS ARTICLE:

GALLO, Marlon M.; MOLA, Eneko; MUGURUZA, Ignacio; UGARTEMENDIA, Aitzol, ABAD, Gonzalo; CABEZUELO, David
EXPERIMENTAL COMPARATIVE STUDY BETWEEN MPPT, HYBRID P&O AND FUZZY CONTROL FOR A SMALL WIND TURBINE APPLICATION. DYNA Energía y Sostenibilidad, January-December 2021, vol.10, [12 p.]. DOI: <https://doi.org/10.6036/ES10295>

ABSTRACT

This study focuses on a comparison between different maximum power extraction controls for a small wind turbine application. In this case, a vertical axis wind turbine (VAWT) coupled to a permanent magnet synchronous generator (PMSG) is used. The analysis is performed for variable winds, so that a real small wind turbine application is simulated. An experimental platform and a wind tunnel are used to recreate the different wind profiles. Diverse controls are compared, a "classical" MPPT, a hybrid Perturb & Observe control and a fuzzy control. Artificial intelligence allows the creation of control algorithms that are not bound by the mechanical parameters of the wind turbine, thus avoiding the need to characterize the wind turbine and define the maximum power curve. It is determined that, for almost constant wind profiles, the hybrid Perturb & Observe extracts more energy. However, for the same profile with greater variability, the fuzzy controller extracts more energy.

Keywords: MPPT, small wind turbine, P&O, Fuzzy Logic, wind tunnel, vertical axis wind turbine (VAWT), Darrieus, Savonius, permanent magnet synchronous generator (PMSG), control comparison, variable wind profile, artificial intelligence

RESUMEN

Este estudio se centra en hacer una comparativa entre diferentes controles de extracción de máxima potencia para una aplicación minieólica. En este caso, se utiliza una aeroturbina de eje vertical acoplada a un generador síncrono de imanes permanentes. El análisis se realiza para vientos variables, de manera que se emula una aplicación de minieólica real. Para recrear los diferentes perfiles de viento se utiliza una plataforma experimental y un túnel de viento. Se comparan diversos controles, un MPPT "clásico", un control Perturba y Observa híbrido y un control basado en lógica difusa. La inteligencia artificial permite crear algoritmos de control no sujetos a los parámetros mecánicos de la aeroturbina, de esta forma se evita la necesidad de caracterizar el aerogenerador y de definir la curva de máxima potencia. Se determina que, para perfiles de viento más constantes, el Perturba y Observa híbrido extrae mayor energía. Sin embargo, para el mismo perfil con mayor variabilidad, el controlador mediante lógica difusa extrae más energía.

Palabras clave: MPPT, minieólica, P&O, Lógica Difusa, túnel de viento, aeroturbina de eje vertical, Darrieus, Savonius, generador síncrono de imanes permanentes, comparativa de controles, perfil de viento variable, inteligencia artificial

	<p>EXPERIMENTAL COMPARATIVE STUDY BETWEEN MPPT, HYBRID P&O AND FUZZY CONTROL FOR A SMALL WIND TURBINE APPLICATION</p>	<p>ENERGY TECHNOLOGY</p>
<p>RESEARCH ARTICLE</p>	<p>Marlon M. Gallo, Eneko Mola, Ignacio Muguruza, Aitzol Ugartemendia, Gonzalo Abad, David Cabezuolo.</p>	<p>Non-conventional energy sources</p>

1.- INTRODUCTION

In the last five decades, the global climate has undergone a change, which is a problem in society that diversifies from economic, social, security and health [1]. The correlation between air pollution due to the energy industry has been demonstrated [2]. In 2007, CO₂ emissions from the global electricity industry were estimated at 10 billion tons per year, according to the Center for Global Development [3]. A developed country such as the United States, relates 33% of total CO₂ emissions to electricity production, in 2018 [4].

The building sector consumes about one-third of final energy and releases about 28% of global energy-related CO₂ emissions. Electricity use in buildings increased moderately during 2010-2018, at more than 2% per year [5]. Increasing renewable energy production is therefore a key factor in decarbonising this sector, as well as using these types of resources domestically.

Globally 27.3% of the consumed energy is renewable, 5.9% of which is wind power [5]. Apart from large wind farms, small wind power generation can be very useful, such as in rural areas where it can be hybridised with photovoltaic technology [6][7].

IEC 61400 defines small wind turbines as wind turbines with a rotor swept area of less than 200 m², generating a voltage of less than 1000 Vac or 1500 Vdc. This article will focus on this technology.

The electrical configuration of a wind turbine is distinguished between fixed-speed and variable-speed wind turbines [8]. The electrical configuration of a wind turbine is distinguished between fixed speed and variable speed wind turbines [8]. Variable topology turbines can operate over a range of wind speeds, which allows more power to be extracted than a fixed-speed turbine [8]. Within the variable-speed wind turbines, they can be coupled with an asynchronous or synchronous motor, where the two most used are the doubly-fed induction generator (DFIG) and permanent magnet synchronous generator (PMSG) [9].

One of the main advantages of the PMSG is the ability to eliminate the gearbox [8] and its easy applicability in electrical systems where low wind speeds are demanded [10], in addition to its low voltage [10][11], making this configuration ideal for small wind power generation applications.

Depending on the orientation of the axis of rotation of the wind turbine, it is classified into two types: Horizontal Axis Wind Turbines (HAWT) and Vertical Axis Wind Turbines (VAWT) [13]. VAWTs are ideal wind turbines for a small wind application because the operation is independent of wind direction and they are suitable for rooftops (even if there are strong winds, a structurally strong tower is not needed) [8].

Taking into account the electrical (generator type) and mechanical (turbine rotating shaft) characteristics, this paper establishes a study of a wind turbine with a PMSG electrical machine and a VAWT topology as a turbine for a small wind turbine application.

Regarding the control of the electrical machines and the converter, it is usual to use classical controls such as obtaining the highest power with the MPP (Maximum Power Point) curve by means of the MPPT (Maximum Power Point Tracking) control, [14]. On the other hand, a perturbation system is used in order to obtain a higher power and thus move along the wind turbine characteristics curve, reaching the maximum efficiency. This method is known as Perturb and Observe or P&O [15].

On the other hand, there are other types of controls that are not so common in wind power generation, such as controls using Artificial Intelligence (AI). Among them, fuzzy logic used in other applications such as automotive [16] stands out. Currently, research in the wind energy field is focused on improving the efficiency of the system, extracting the greatest amount of energy, and storing it in the batteries through this type of control [17].

The main contributions of this work are summarized in the following points:

- Comparison of controls that consider the aerodynamic characteristics of the turbine with respect to one that does not, in a small wind generation application, Figure 1. In this regard, different wind profiles will be used in order to determine its performance.
- Analysis of the advantages and disadvantages of characterising a turbine for conventional MPPT control.
- Study of the opportunities offered by using fuzzy logic in the context of small wind power generation.

	<p>EXPERIMENTAL COMPARATIVE STUDY BETWEEN MPPT, HYBRID P&O AND FUZZY CONTROL FOR A SMALL WIND TURBINE APPLICATION</p>	<p>ENERGY TECHNOLOGY</p>
<p>RESEARCH ARTICLE</p>	<p>Marlon M. Gallo, Eneko Mola, Ignacio Muguruza, Aitzol Ugartemendia, Gonzalo Abad, David Cabezuolo.</p>	<p>Non-conventional energy sources</p>

The 2nd chapter explains the theoretical framework of the controls used in which the authors base their subsequent experimental comparison. The next section sets out the conditions under which the experiments are carried out and the procedures used to achieve the aims or objectives of the research. The 4th chapter shows the results obtained in the experimental platform by means of graphs and tables, explaining the reason for the phenomena that occur. Finally, the article concludes with the conclusions found throughout the study.

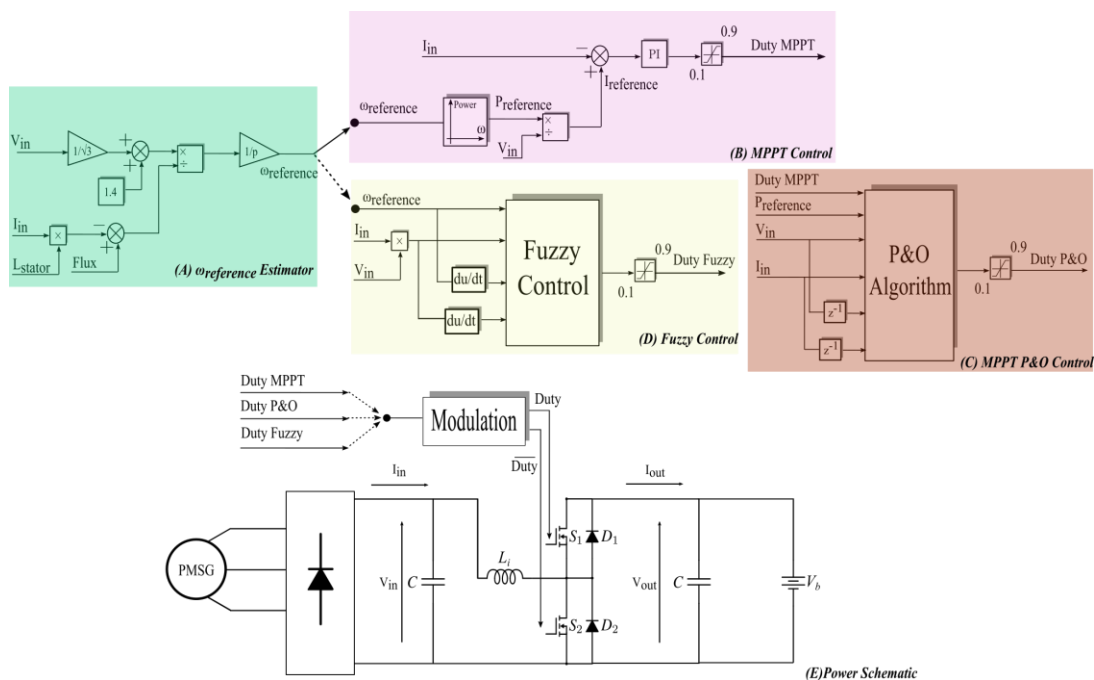



Figure 1. Block diagram of the controls to be analysed and power scheme used

2.- ANALYSED CONTROL METHODS

A wind turbine rotational speed ω estimator has been developed, Figure 1(A), which will be used in the different controls. The voltage drop of the diode bridge has been taken into account in the estimator. It requires DC voltage and current measurements. The measured voltage is divided by the subtraction between the electromagnetic flux of the generator and the product between the stator inductance and the measured DC current [18]. In this way the value of the electrical angular velocity in rad/s is obtained. This is therefore an electrical angular velocity estimator. So, dividing this value by the pairs of poles, it is achieved the ω necessary for its later use in the different controls.

2.1.- “Classical” MPPT

After characterising the aeroturbine and achieving the maximum power characteristic curve, a control can be implemented to achieve the maximum power depending on the ω of the wind turbine [19]. For this purpose, a "classical" MPPT control has been employed using the estimated angular velocity as input data to the maximum power curve, and the current measurement on the DC side of the diode rectifier. In Figure 1(B), the control scheme used for the MPPT is shown. The power given by the curve is used as a reference, this is divided by the voltage measured on the DC side of the rectifier and a current reference is obtained. This current reference is subtracted from the measured current achieving an error between both, in order to attenuate or eliminate this error a PI controller is applied. The PI controller obtains the duty-cycle value at its output and by varying this value by means of the PI itself the error is corrected. A saturation has been established at the PI output so that the duty-cycle does not exceed the value of 0.9 or fall below 0.1. This is done to prevent the semiconductors of the DC-DC converter from not having a full conduction duty cycle and their temperature from rising above the maximum value, damaging the components themselves.

	<p>EXPERIMENTAL COMPARATIVE STUDY BETWEEN MPPT, HYBRID P&O AND FUZZY CONTROL FOR A SMALL WIND TURBINE APPLICATION</p>	<p>ENERGY TECHNOLOGY</p>
<p>RESEARCH ARTICLE</p>	<p>Marlon M. Gallo, Eneko Mola, Ignacio Muguruza, Aitzol Ugartemendia, Gonzalo Abad, David Cabezuolo.</p>	<p>Non-conventional energy sources</p>

2.2.- MPPT Hybridized with P&O

The main objective of the control is to obtain at all times the maximum power that can be extracted from the wind turbine, that is why it has been decided to implement a correction to the MPPT control by combining it with a Perturb and Observe control, [20]. The Perturb and Observe algorithm requires the same measurements as the classical MPPT. Using the acquired currents and voltages, the power measurement is obtained, and an iterative comparison of power and voltage is performed to make the decision to vary the duty cycle value. The measured or acquired variables required to create this control are shown in Figure 1(C).

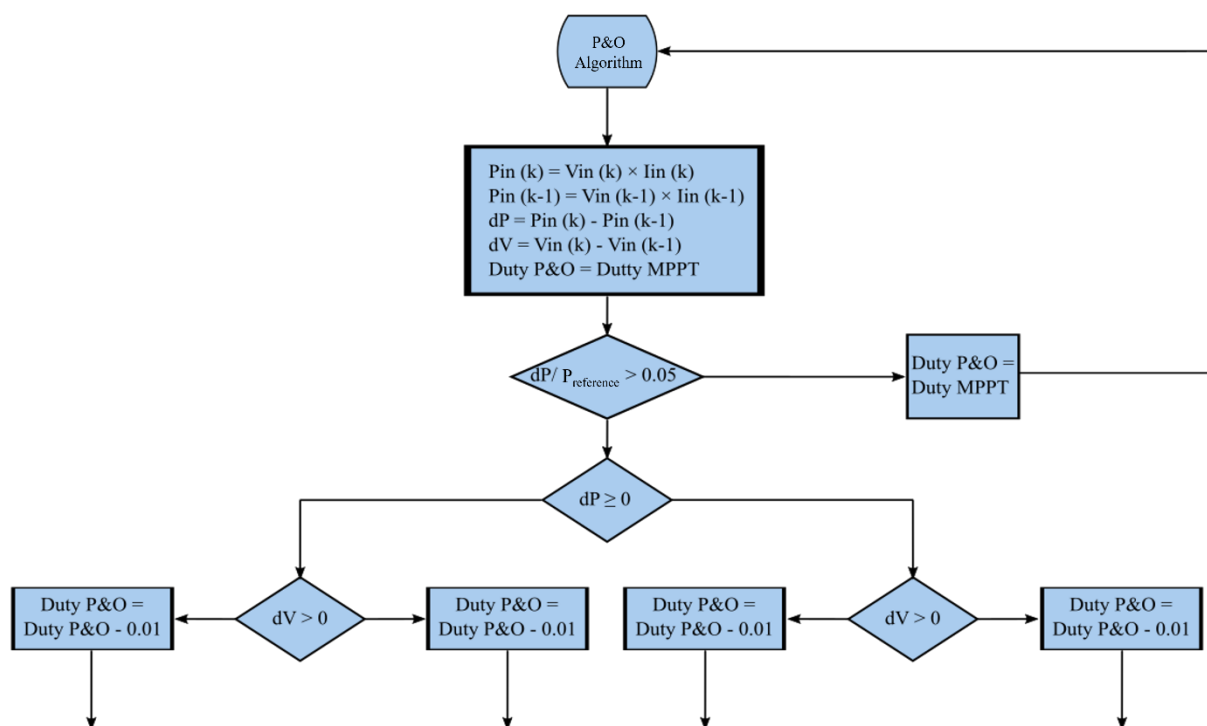



Figure 2. P&O Algorithm

As can be seen in the diagram in Figure 2, initially, the control acts with the power and duty cycle references obtained by means of the "classical" MPPT. When the division between the input power difference and the MPPT reference power is less than 5 %, the control starts operating by means of Perturb and Observe, disturbing the duty cycle value in one way or another, depending on the value of the power difference and the voltage difference. These differences are acquired by means of the voltage and current measurements and their previous values. The sampling time of these variables is 250 microseconds. The output value of this algorithm, i.e., the duty cycle, has a sampling time of 200 microseconds.

The DC-DC converter absorbs more or less current by increasing or decreasing the voltage of the converter inductance. For this reason, the stator voltage changes and the counter-electromotive force changes as well. The latter parameter is directly related to the ω of the wind turbine, so changing one changes the other as well.

	<p style="text-align: center;">EXPERIMENTAL COMPARATIVE STUDY BETWEEN MPPT, HYBRID P&O AND FUZZY CONTROL FOR A SMALL WIND TURBINE APPLICATION</p>	<p style="text-align: center;">ENERGY TECHNOLOGY</p>
<p style="text-align: center;">RESEARCH ARTICLE</p>	<p style="text-align: center;">Marlon M. Gallo, Eneko Mola, Ignacio Muguruza, Aitzol Ugartemendia, Gonzalo Abad, David Cabezuolo.</p>	<p style="text-align: center;">Non-conventional energy sources</p>

2.3.- Fuzzy

Fuzzy logic control is a type of algorithm used to emulate human thought, with its ambiguities, inaccuracies, not being able to be represented by a discrete value such as a 0 or a 1 [21]. It is governed by a rule-based system where a degree of membership is set to a value in the range of [0, 1] depending on the value of the variable. The membership functions can be of different types and there is no established criterion when choosing it, it is usually a criterion based on experience.

Each value is assigned a concept, or linguistic label, and the set of these values establishes a fuzzy set. An example of this type of labels corresponds to [NB NM NS Z PS PM PB], meaning respectively [Negative Big, Negative Middle, Negative Small, Zero, Positive Small, Positive Middle, Positive Big].

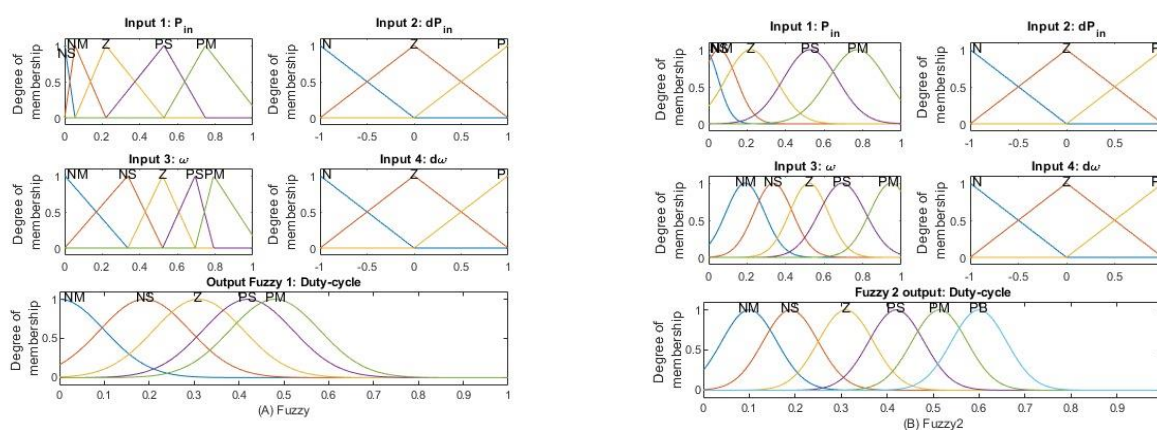



Figure 3. Membership functions, (A) first version of Fuzzy controller, (B) second version Fuzzy2.

From the electrical measurements, the current I_{in} and the voltage V_{in} are obtained (Figure 1(D)); by multiplying both terms, the instantaneous power P_{in} is obtained as a reflection of the capacity of power production by the turbine, while from V_{in} is possible to estimate the ω . In order to have a greater number of cases under control and to be able to act on them, the variation of the angular velocity and power over time is also taken into account.

For the case studied, 4 input variables have been established: power P_{in} , derivative of power dP_{in} , mechanical angular velocity of the turbine ω derived from the mechanical angular velocity $d\omega$. The output U is set as the duty cycle of the DC-DC converter.

The wind tunnel has been used to establish a given wind speed and a sweep of the duty cycle has been made, identifying 3 operating points (points of maximum membership of the linguistic values [NS, Z, PS]) where P_{in} is maximum and its corresponding value of ω . The NM value corresponds to how the controller should behave at ω low, the PM values are the maximum experimentally observed values of both power and ω .

	<p>EXPERIMENTAL COMPARATIVE STUDY BETWEEN MPPT, HYBRID P&O AND FUZZY CONTROL FOR A SMALL WIND TURBINE APPLICATION</p>	<p>ENERGY TECHNOLOGY</p>
<p>RESEARCH ARTICLE</p>	<p>Marlon M. Gallo, Eneko Mola, Ignacio Muguruza, Aitzol Ugartemendia, Gonzalo Abad, David Cabezuolo.</p>	<p>Non-conventional energy sources</p>

The function of the increments is to detect changes in the system in order to act according to the rules. In the increments the Z value corresponds to the steady state while N and P are used when the values of the variables decrease or increase.

The controller rules have been designed so that:

- On a permanent basis, it tends to a given operating point.
- In case of an increase of ω to have a higher duty cycle, so that by increasing V_{in} , the current I_{in} decreases, and consequently the counter electromagnetic torque is lower, thus favouring the increase of the ω with an increase of the wind speed V_w .
- If V_w decreases, the tendency will be to maintain the duty cycle in which the system is in order to prevent the system from reducing too much the ω .
- Depending on having positive or negative increases of P_{in} and/or ω , corrective actions are applied to the work cycle.

After several experiments with the rest of the controls, the initial fuzzy controller in Figure 3 (A) has been modified by choosing a Gaussian membership function instead of a triangular one to make transitions smoother and more gradual as can be seen in Figure 3 (B). An additional membership function has been added representing the value [PB] for the output, the purpose of which is to capture those cases in which a faster rise of the controller is needed in the event of sudden increases of ω and P_{in} , a situation which occurs when V_w increases, and the turbine inertia is overcome.

3.- CHARACTERIZATION OF THE WIND TURBINE AND EXPERIMENTAL PLATFORM

The tests were carried out using a turbulent air tunnel, which consists of an ABB ACS550 commercial drive controller, which is responsible for making variations in wind speed incident on the wind turbine. The wind turbine is coupled to a permanent magnet synchronous generator, with 400 W rated power, 24 Vac rated voltage and 10 pairs of poles, Figure 1 (E). All this is coupled to a power converter, single-branch H-bridges, installed with a dSpace rapid prototyping system (DS1103 PPC Controller Board), which is responsible for implementing both different wind profiles in the tunnel drive, as well as implementing the control algorithms worked in MATLAB-SIMULINK. At the output there are two 12V batteries in series (Xunzel™ model SOLARX™-30).

The wind turbine used is a hybrid of Darrieus and Savonius type. In order to know the characteristics of the machine coupled to the wind turbine, several characterization tests have been carried out, such as the no-load test, the short-circuit test or the load test, the latter being the one used to obtain the power characteristic curves.

The MPPT control is based on trying to find the maximum power point for each V_w value of the wind turbine, where the maximum power curve is determined, [8][19]. In order to determine the parabola exerted by this curve, a test has been carried out with adjustable or variable loads, more specifically variable resistors. The test has been carried out in two ways: First, by varying the wind speed using a turbulent wind tunnel with the ABB ACS550 variator and a fixed resistance of 10 Ω ; then, by setting V_w and varying the load resistance. The resistor imposes an electrical power, resulting in an electromagnetic torque opposite to the torque imposed by the wind. By varying the wind speed, it is possible to either increase or decrease the ω of the wind turbine in question and by varying the load, it is possible to vary the ω of the turbine, as well.

	<p>EXPERIMENTAL COMPARATIVE STUDY BETWEEN MPPT, HYBRID P&O AND FUZZY CONTROL FOR A SMALL WIND TURBINE APPLICATION</p>	<p>ENERGY TECHNOLOGY</p>
<p>RESEARCH ARTICLE</p>	<p>Marlon M. Gallo, Eneko Mola, Ignacio Muguruza, Aitzol Ugartemendia, Gonzalo Abad, David Cabezuolo.</p>	<p>Non-conventional energy sources</p>

At the end of the load test, several curves are obtained. In this case, having varied the wind speed for four different points, four different power curves have been obtained with respect to different values of ω . Since the curve used by the MPPT control is the maximum power curve, the maximum power points of the obtained curves have been chosen to create a new curve called maximum generator power curve [8]. The platform used is shown in Figure 4.



Figure 4. Darrieus - Savonius Wind Turbine and Wind Tunnel.

4.- EXPERIMENTAL RESULTS

The controllers have been tested for three wind profiles and the results are shown in Figures 5, 6 and 7. These are based on real wind profiles measured at different locations.

Wind profile 1 and 2 are the same, the difference lies in the time axis where in profile 2 the duration of profile 1 has been shortened by half. The reason for this reduction was to compare the behaviour of the controls with a more constant wind profile over time and a more variable one (1). For wind profile 3, a short duration profile has been repeated four times with gusty wind whose variability is greater than in previous profiles, adding a time without wind to study the difference between the power produced starting from rest and with an initial ω .

$$Variability = \frac{Variance (Wind speed)[m s^{-1}]}{Profile duration [min]} \quad (1)$$

For wind profiles with lower variability and therefore more constant, the P&O is able to extract more energy. On the contrary, for the same profile with higher variability, and for a profile with high variability, the fuzzy controllers manage to extract more energy. Comparing the performances of the fuzzy controllers, the first version reacts faster to wind changes while the second version performs better at high wind and turning speeds.

Observing the response of the system in wind profile 3, the same conclusions are obtained as for wind profile 2. However, it should be noted that the energy required to accelerate the turbine from a rest position directly influences the power it is able to produce. For the same profile, with the turbine initially spinning, more power is achieved.

The fuzzy controls, being at low rotational speeds, prioritise increasing speed rather than extracting more power, which is why for more variable winds over time they are able to extract more energy.

On the other hand, for more uniform winds over time, the P&O Hybrid seeks to increase energy production and achieves better results than the rest of the controllers (results shown in Table 1), however, at low rotational speeds and greater wind variability, extracting more power implies a reduction in acceleration with an increase in V_w , delaying the increase in speed and preventing the extraction of more energy with new gusts of wind.

	<p>EXPERIMENTAL COMPARATIVE STUDY BETWEEN MPPT, HYBRID P&O AND FUZZY CONTROL FOR A SMALL WIND TURBINE APPLICATION</p>	<p>ENERGY TECHNOLOGY</p>
<p>RESEARCH ARTICLE</p>	<p>Marlon M. Gallo, Eneko Mola, Ignacio Muguruza, Aitzol Ugartemendia, Gonzalo Abad, David Cabezuolo.</p>	<p>Non-conventional energy sources</p>

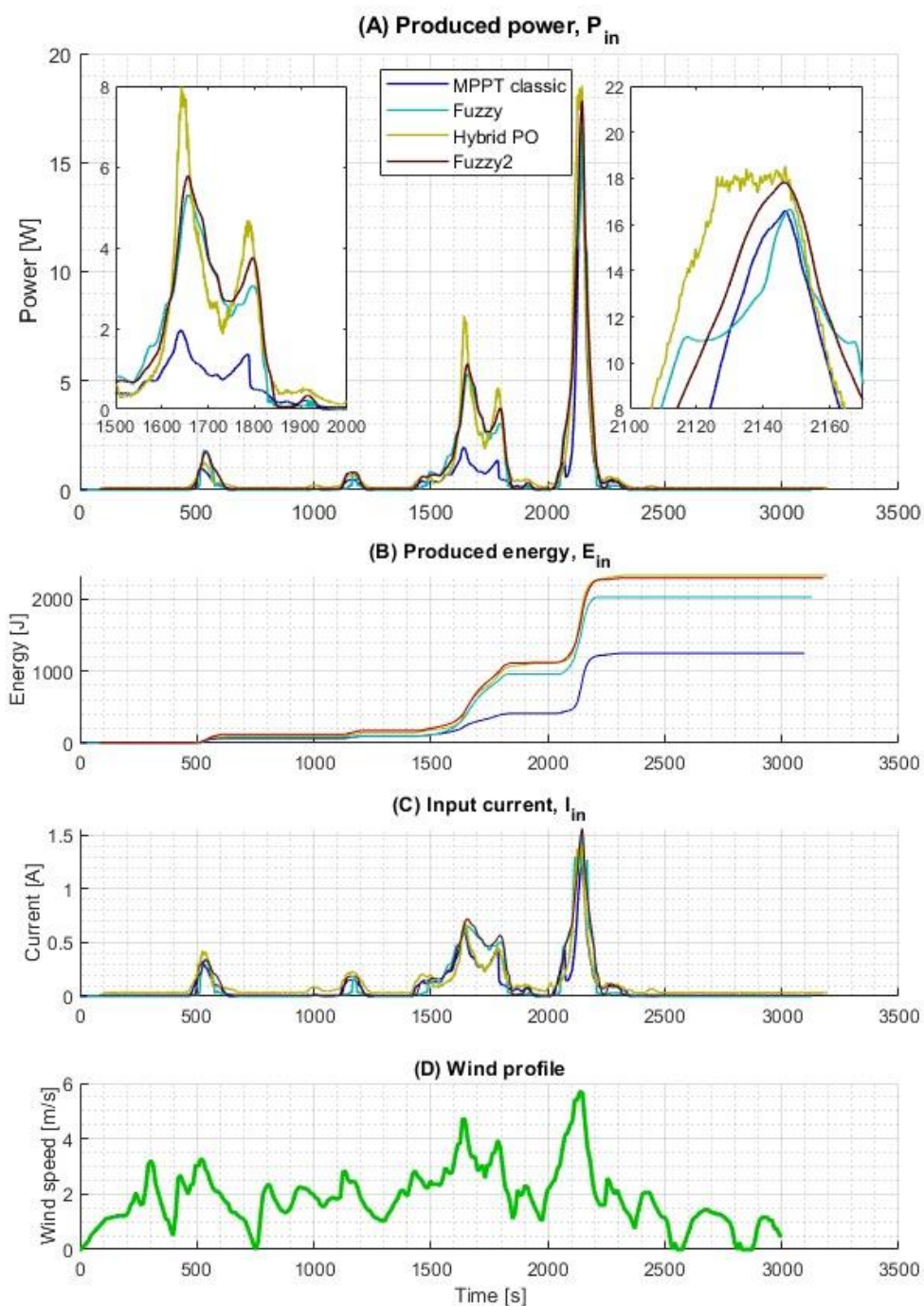



Figure 5. System Response for Wind Profile 1

	<p>EXPERIMENTAL COMPARATIVE STUDY BETWEEN MPPT, HYBRID P&O AND FUZZY CONTROL FOR A SMALL WIND TURBINE APPLICATION</p>	<p>ENERGY TECHNOLOGY</p>
<p>RESEARCH ARTICLE</p>	<p>Marlon M. Gallo, Eneko Mola, Ignacio Muguruza, Aitzol Ugartemendia, Gonzalo Abad, David Cabezuolo.</p>	<p>Non-conventional energy sources</p>

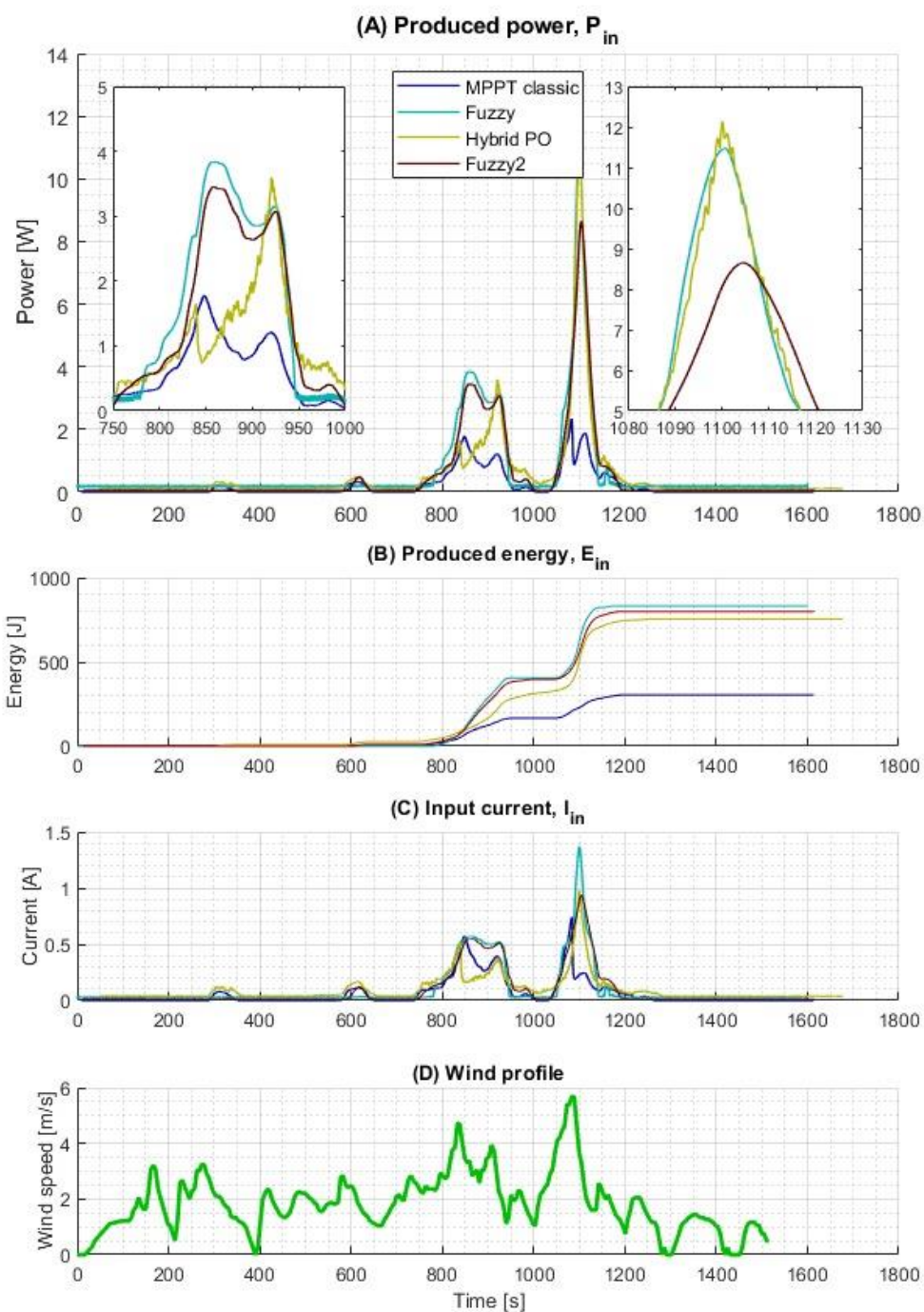



Figure 6. System Response for Wind Profile 2

	<p>EXPERIMENTAL COMPARATIVE STUDY BETWEEN MPPT, HYBRID P&O AND FUZZY CONTROL FOR A SMALL WIND TURBINE APPLICATION</p>	<p>ENERGY TECHNOLOGY</p>
<p>RESEARCH ARTICLE</p>	<p>Marlon M. Gallo, Eneko Mola, Ignacio Muguruza, Aitzol Ugartemendia, Gonzalo Abad, David Cabezuolo.</p>	<p>Non-conventional energy sources</p>

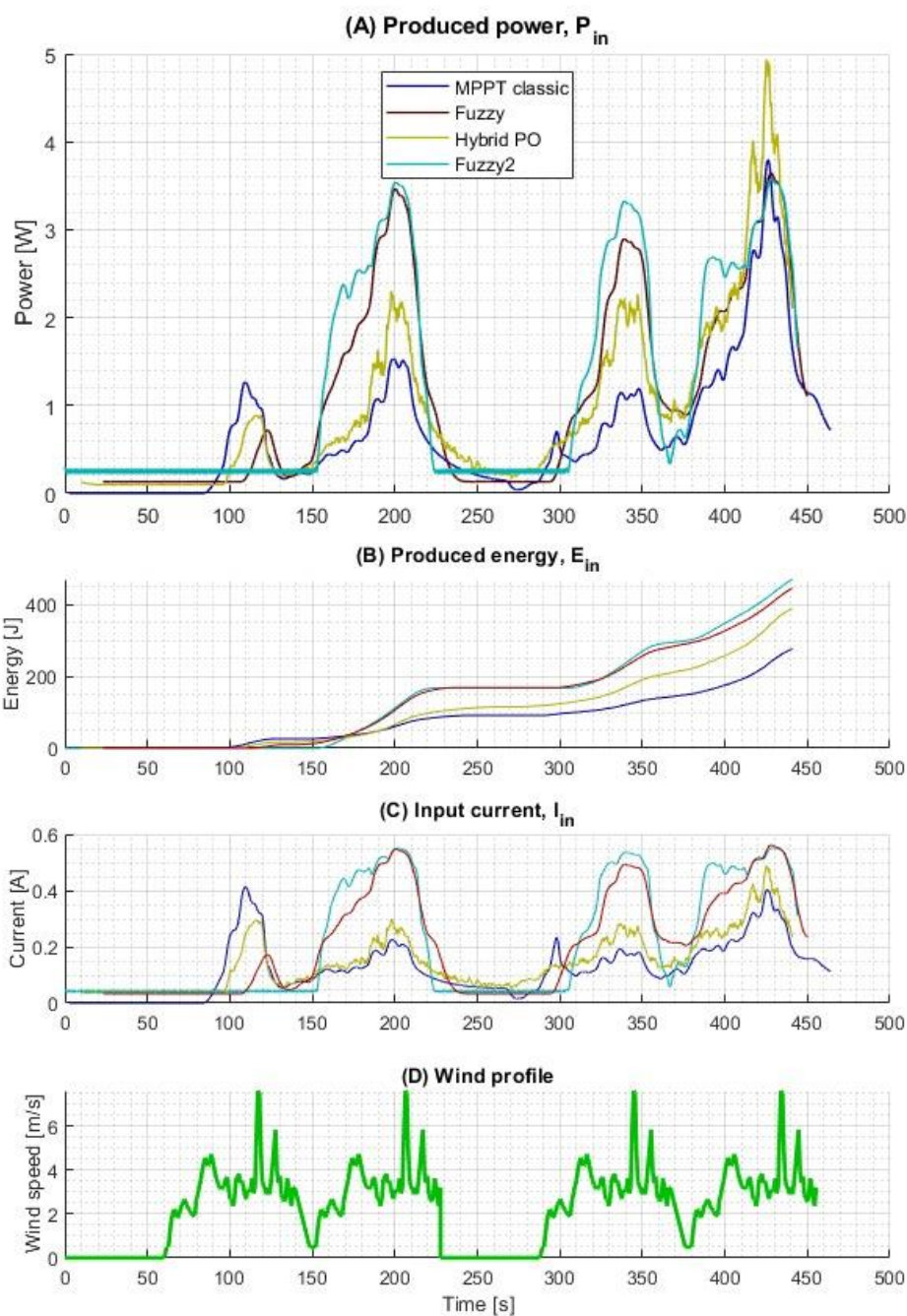



Figure 7. System Response for Wind Profile 3

	EXPERIMENTAL COMPARATIVE STUDY BETWEEN MPPT, HYBRID P&O AND FUZZY CONTROL FOR A SMALL WIND TURBINE APPLICATION	ENERGY TECHNOLOGY
RESEARCH ARTICLE	Marlon M. Gallo, Eneko Mola, Ignacio Muguruza, Aitzol Ugartemendia, Gonzalo Abad, David Cabezuolo.	Non-conventional energy sources

	Average wind speed [m/s]	Profile Variability	Variables	MPPT	P&O	Fuzzy	Fuzzy2
Profile 1	1,800	0,023	Max. average power [W]	16,60	18,52	16,67	17,83
			Total energy [J]	1249,55	2330,39	2029,10	2292,22
			Maximum omega [rad/s]	18,67	19,87	16,85	17,33
Profile 2	1,800	0,046	Max. average power [W]	2,34	12,14	11,47	8,65
			Total energy [J]	304,02	755,20	832,78	798,47
			Maximum omega [rad/s]	10,73	17,35	13,22	13,39
Profile 3	2,357	0,748	Max. average power [W]	3,79	4,94	3,57	3,65
			Total energy [J]	276,15	388,96	470,20	445,74
			Maximum omega [rad/s]	12,74	13,93	10,05	9,78

Table 1. Final Results

5.-CONCLUSIONS

In this paper, several types of control have been presented and implemented in an experimental platform, aimed at a small wind turbine application. The results obtained experimentally in different wind profiles have been analysed, making a comparison of the advantages and disadvantages of the performance of the different controllers.

It has been seen that the MPPT hybridised with P&O produces a higher peak power in all the wind profiles studied, obtaining more energy than the rest of the controls for low variability winds. On the contrary, for high instability winds, the fuzzy control obtains better energy extraction results. It has been corroborated that for low rotational speeds, the reduction of the counterelectromotive force favours the increase in speed, obtaining better results in energy extraction.

REFERENCES

- [1] Li HM, Wang XC, Zhao XF, Qi Y, et al. "Understanding systemic risk induced by climate change". *Advances in Climate Change Research*. June 2021 DOI: <https://doi.org/10.1016/j.accres.2021.05.006>
- [2] Hu, F., Guo, Y., et al. "Impacts of electricity generation on air pollution: evidence from data on air quality index and six criteria pollutants". *SN Appl. Sci.* 3, 4. December 2020. DOI: <https://doi.org/10.1007/s42452-020-04004-2>
- [3] Carbon Dioxide Emissions From Power Plants Rated Worldwide, 2007. ScienceDaily. Retrieved from <https://www.sciencedaily.com/releases/2007/11/071114163448.htm> [Consulta: 18 de octubre de 2021]
- [4] Electricity and the environment - U.S. Energy Information Administration (EIA), 2021. Eia.gov. Retrieved from: <https://www.eia.gov/energyexplained/electricity/electricity-and-the-environment.php> [Consulta: 18 de octubre de 2021]
- [5] Renewables 2020 Global Status Report, 2020. Retrieved from: https://www.ren21.net/wp-content/uploads/2019/05/gsr_2020_full_report_en.pdf [Consulta: 18 de octubre de 2021]
- [6] IEC 61400
- [7] I. Masenge and F. Mwasilu, et al. "Hybrid Solar PV-Wind Generation System Coordination Control and Optimization of Battery Energy Storage System for Rural Electrification," 2020 IEEE PES/IAS PowerAfrica, 2020, pp. 1-5, DOI: [10.1109/PowerAfrica49420.2020.9219890](https://doi.org/10.1109/PowerAfrica49420.2020.9219890).
- [8] Wu B, Lang Y, Zargari N, Kouro S, et al. "Power Conversion and Control of Wind Energy Systems", Wiley-Blackwell, Oxford, 2011, ISBN: 9781118029008
- [9] H.H. Li, Z. Chen, et al. "Overview of different wind generator systems and their comparisons", in *IET Renewable Power Generation*, Vol. 2, No. 2, 2008, pp.123-138. DOI: [10.1049/iet-rpg:20070044](https://doi.org/10.1049/iet-rpg:20070044)

	<p style="text-align: center;">EXPERIMENTAL COMPARATIVE STUDY BETWEEN MPPT, HYBRID P&O AND FUZZY CONTROL FOR A SMALL WIND TURBINE APPLICATION</p>	<p style="text-align: center;">ENERGY TECHNOLOGY</p>
<p style="text-align: center;">RESEARCH ARTICLE</p>	<p style="text-align: center;">Marlon M. Gallo, Eneko Mola, Ignacio Muguruza, Aitzol Ugartemendia, Gonzalo Abad, David Cabezuolo.</p>	<p style="text-align: center;">Non-conventional energy sources</p>

[10] A. Hebala, W. A. M. Ghoneim and H. A. Ashour, "Different design approaches of surface mounted high performance PMSG," 2017 Intl Conf on Advanced Control Circuits Systems (ACCS) Systems & 2017 Intl Conf on New Paradigms in Electronics & Information Technology (PEIT), 2017, pp. 85-90, DOI: [10.1109/ACCS-PEIT.2017.8303024](https://doi.org/10.1109/ACCS-PEIT.2017.8303024).

[11] Nasiri M, Mobayen S, Faridpak B, Fekih A, Chang A, et al. "Small-Signal Modeling of PMSG-Based Wind Turbine for Low Voltage Ride-Through and Artificial Intelligent Studies". Energies 2020, 13, 6685. DOI:<https://doi.org/10.3390/en13246685>

[12] S. Morimoto, H. Nakayama, M. Sanada and Y. Takeda, et al. "Sensorless output maximization control for variable-speed wind generation system using IPMSG," in IEEE Transactions on Industry Applications, Vol. 41, no. 1, pp. 60-67, Jan.-Feb. 2005, DOI: [10.1109/TIA.2004.841159](https://doi.org/10.1109/TIA.2004.841159).

[13] Mittal R, Sandhu K, Jain D. An overview of some important issues related to wind energy conversion system (WECS). International Journal of Environmental science and development 2010;1(4):351.

[14] Kot R, Rolak M, Malinowski M, et al. "Comparison of maximum peak power tracking algorithms for a small wind turbine", in Mathematics and Computers in Simulation, Vol. 91, pp. 29-40, May 2013, DOI: <https://doi.org/10.1016/j.matcom.2013.03.010>.

[15] Hosssam M, Abdel-Raheem Y, Essam E.M. M, et al. "State of the art perturb and observe MPPT algorithms based wind energy conversion systems: A technology review", in International Journal of Electrical Power & Energy Systems, Vol. 126, Part A, March 2021, DOI: <https://doi.org/10.1016/j.ijepes.2020.106598>

[16] Naranjo, J. E., González, C., García, R., Pedro, T. De, & De, I, et al. "Lane-Change Fuzzy Control in Autonomous Vehicles for the Overtaking Maneuver," in IEEE Transactions on Intelligent Transportation Systems, Vol. 9, no. 3, pp. 438-450, Sept. 2008, DOI: [10.1109/TITS.2008.922880](https://doi.org/10.1109/TITS.2008.922880).

[17] Sarrias-Mena R, Fernández-Ramírez L, García-Vázquez CA, Jurado F, et al. "Fuzzy logic based power management strategy of a multi-MW doublyfed induction generator wind turbine with battery and ultracapacitor", in Energy, Vol. 70, pp 561-576, June 2014, DOI: <https://doi.org/10.1016/j.energy.2014.04.049>

[18] Abad G, et al. "Power Electronics and Electric Drives for Traction Applications", Wiley, Mondragon, 2016, ISBN: 978-1-118-95442-3

[19] Abdel-Raheem Y, Essam E.M. M, Hosssam M, et al. "Development of self-adaptive P&O MPPT algorithm for wind generation systems with concentrated search area", in Renewable Energy, Vol. 154, pp 875-893, July 2020, DOI: <https://doi.org/10.1016/j.renene.2020.03.050>

[20] Badreddine L, Smail Z, Bourhaleb MM, Larbi E, et al. "Real Time Study of P&O MPPT Control for Small Wind PMSG Turbine Systems Using Arduino Microcontroller", in Energy Procedia, Vol 111, pp 1000-1009, March 2017, DOI: <https://doi.org/10.1016/j.egypro.2017.03.263>

[21] Bose, Bimal K, et al. "Power electronics and motor drives". Academic Press, London, 2020, ISBN: 9780128238677